

Subject: \_\_\_\_\_ Section: \_\_\_\_\_  
Date: \_\_\_\_\_ 201 \_\_\_\_\_

Name: \_\_\_\_\_  
Period: \_\_\_\_\_

**SIR WINSTON CHURCHILL SECONDARY ELECTRONICS**

# **TOOL IDENTIFICATION- Quiz**

Line drawings created by Chantal Lo (2010).  
Package produced by Kivanç Yıldız.

August 31, 2010

A. Bending

1.

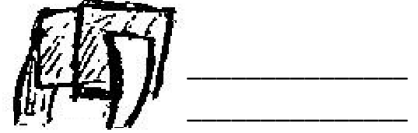
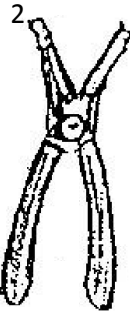
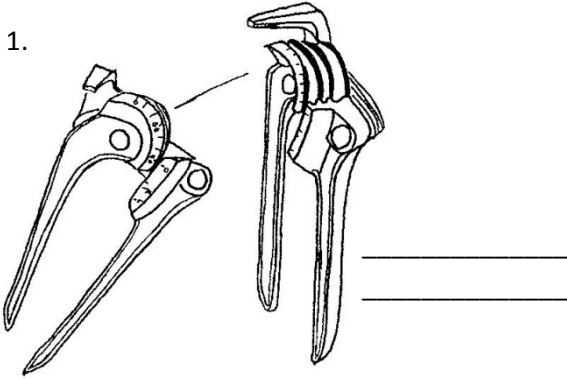

B. Clamping

3.

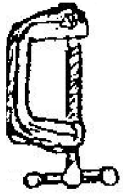

4.

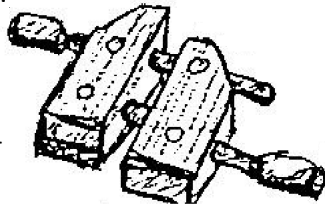

5.

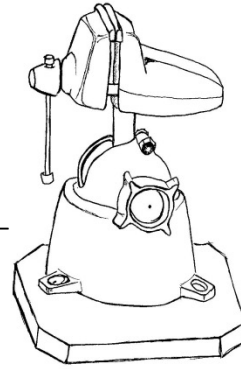

C. Cutting and Punching

6.



7.



8.

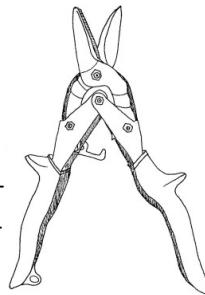

9.

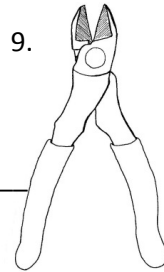

10.



11.

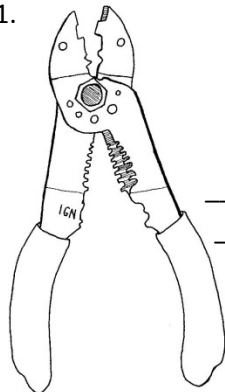

12.

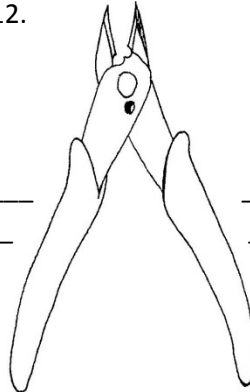

13.

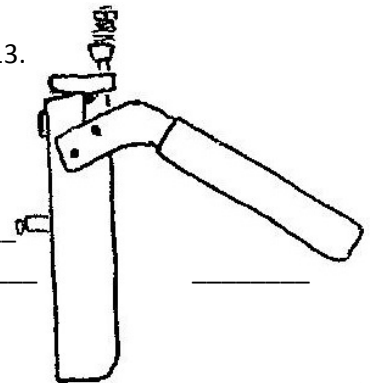

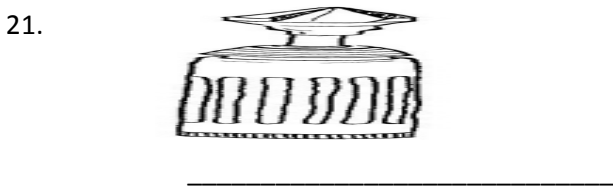
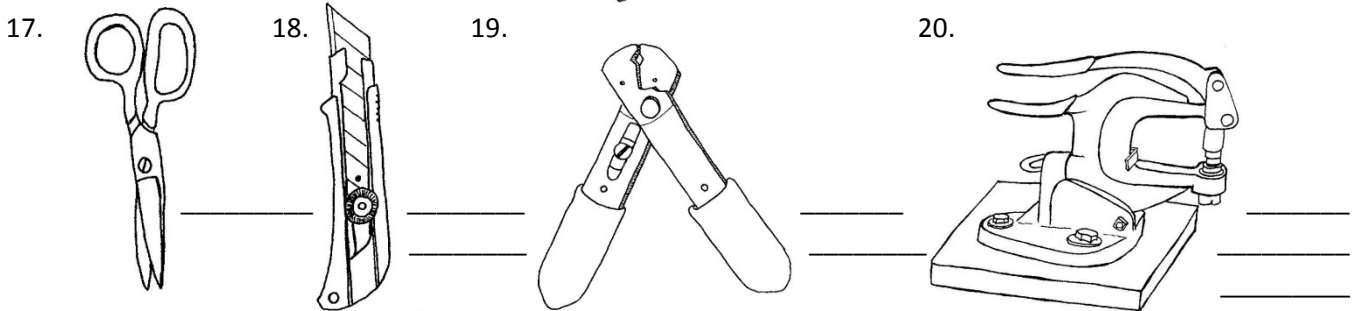
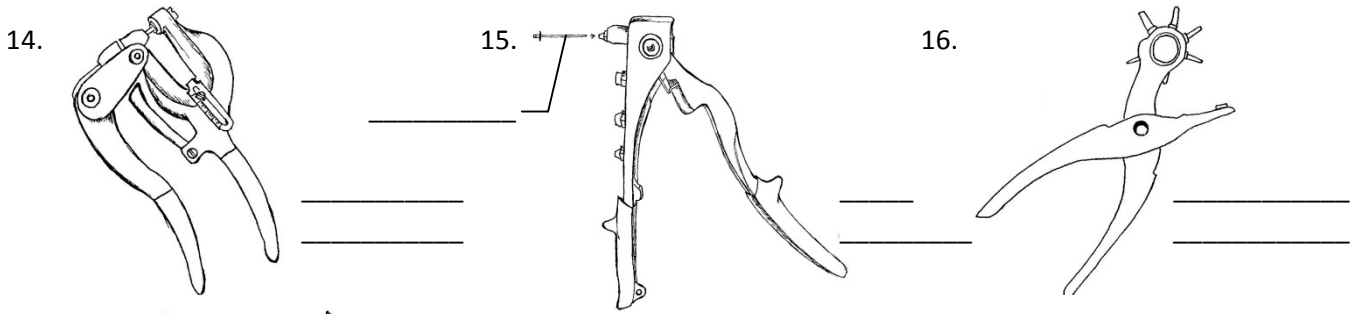

D. Drilling

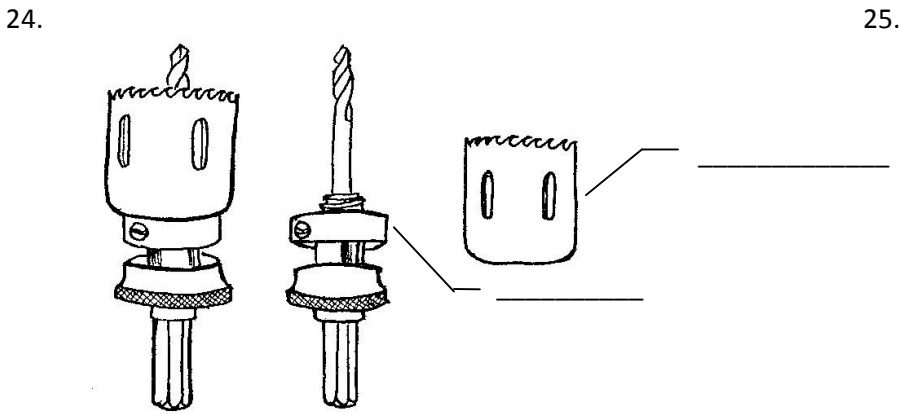
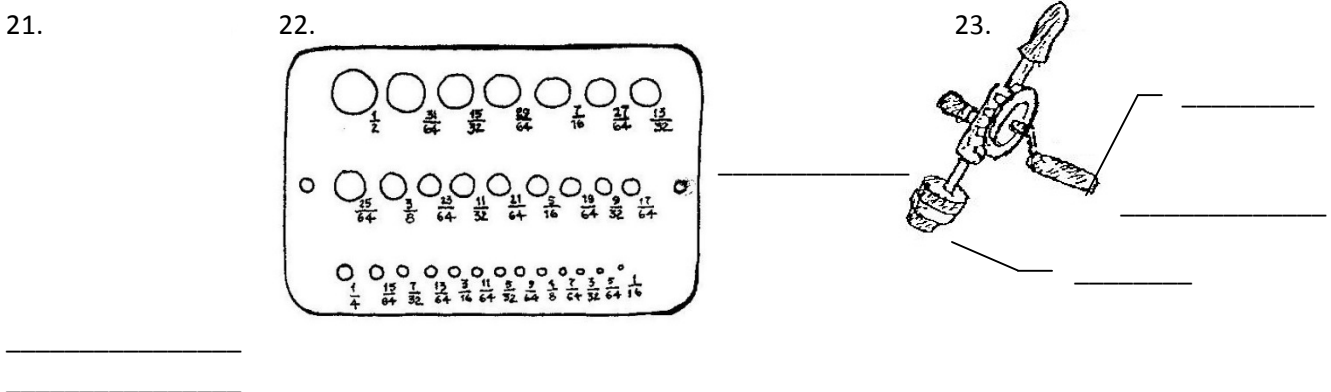

E. Electronics

26.

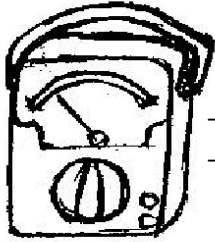

\_\_\_\_\_

\_\_\_\_\_

27.

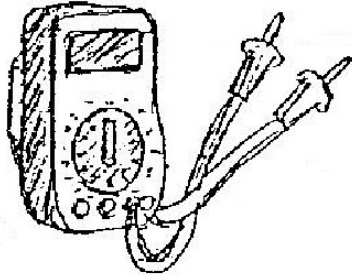

\_\_\_\_\_

\_\_\_\_\_

28.

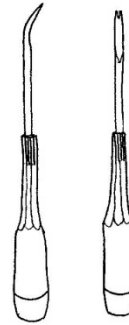

\_\_\_\_\_

\_\_\_\_\_

29.

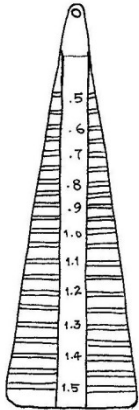

\_\_\_\_\_

\_\_\_\_\_

30.



\_\_\_\_\_

\_\_\_\_\_

F. Files

31.

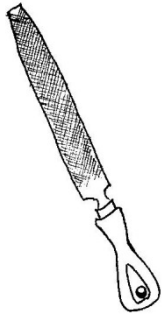

\_\_\_\_\_

\_\_\_\_\_

\_\_\_\_\_

32.

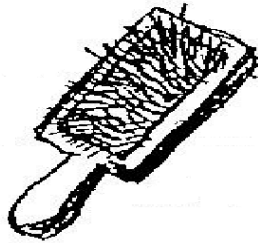

\_\_\_\_\_

33.



34.

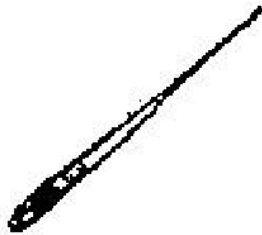

35.



Teeth

36.



⊗ Side

\_\_\_\_ or  
\_\_\_\_  
\_\_\_\_

G. Hammers & Mallet

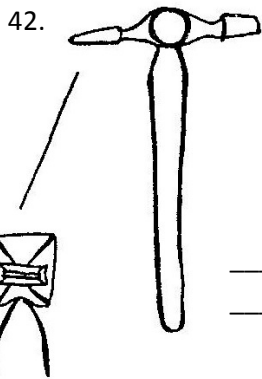
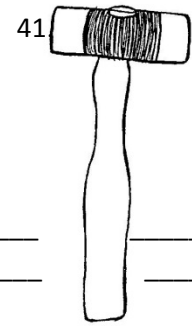
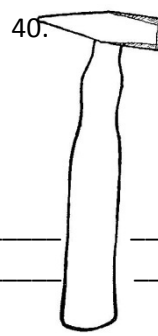
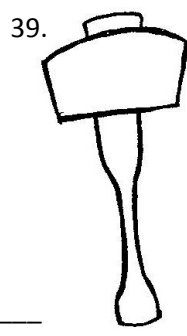
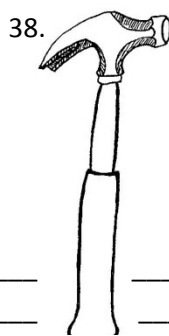
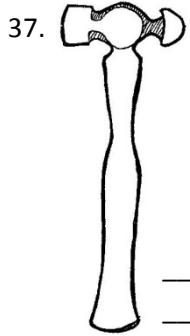

43.

H. Measuring & Layout

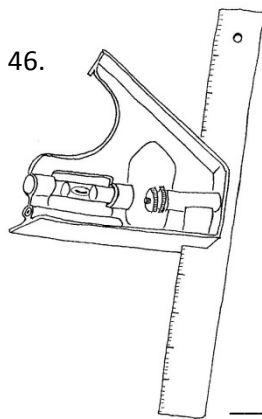
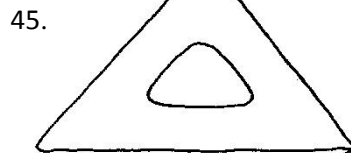
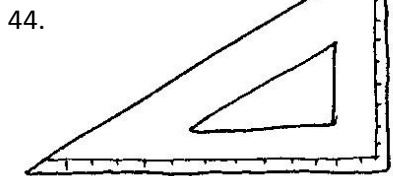

47.

48.

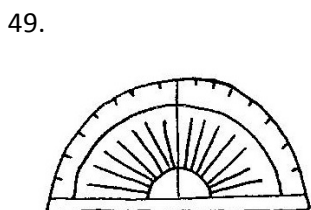
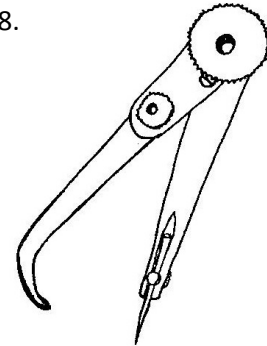

50.

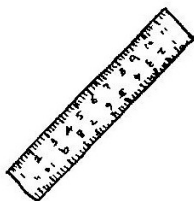

51.

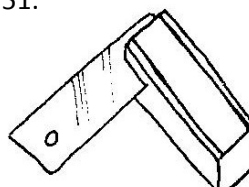

52.

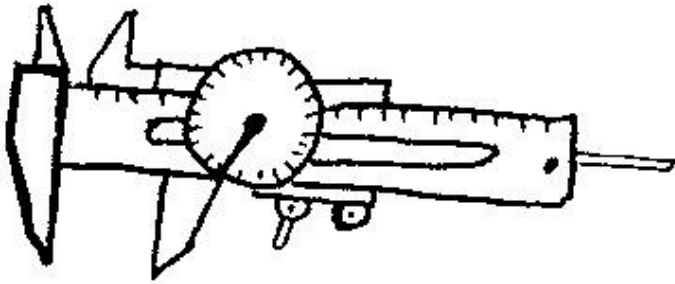

53.

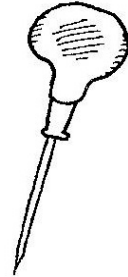

J. Pliers

54.

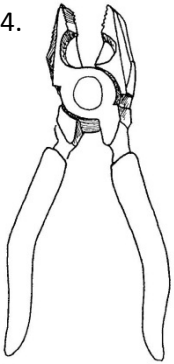

55.

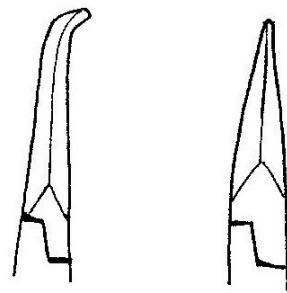
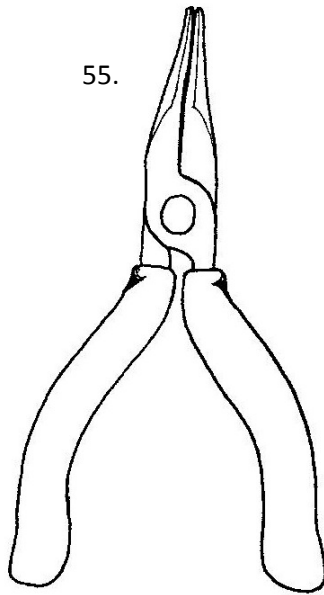

K. Ratchet, Sockets & Wrenches

56.

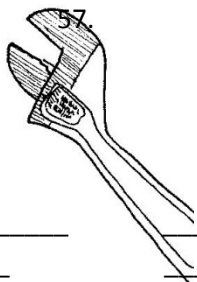
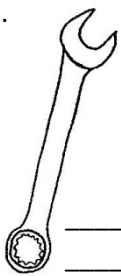

or

58.

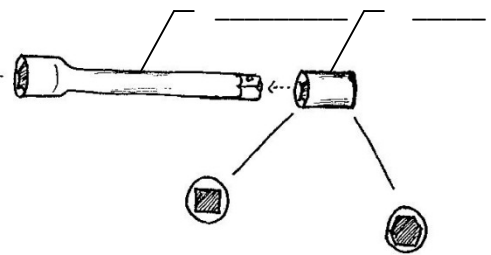
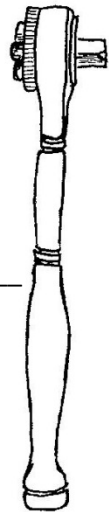

L. Saws

59.

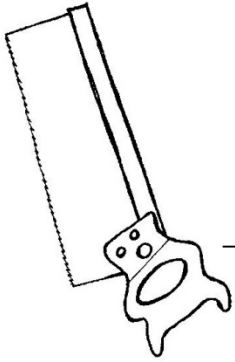

60.

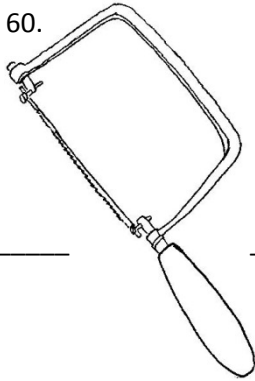

61.

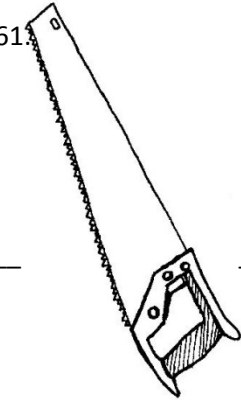

62.

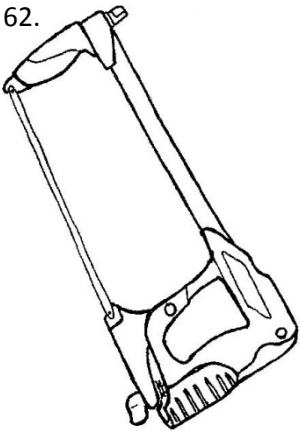

63.

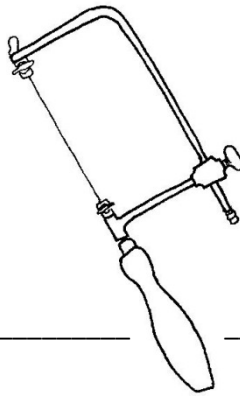

64.

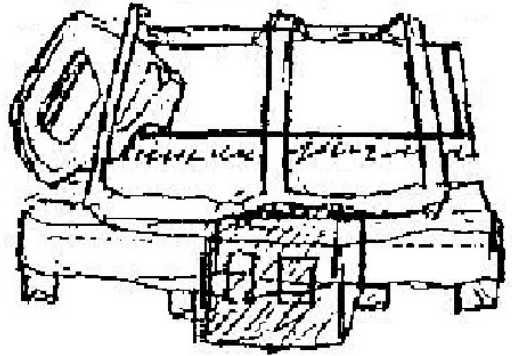

M. Screwdrivers

65.

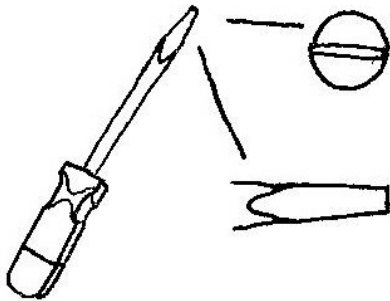

66.

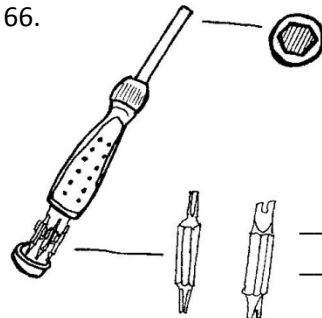

67.

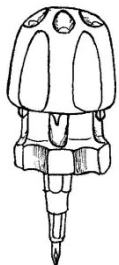

68.

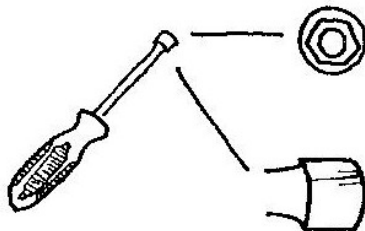

69.

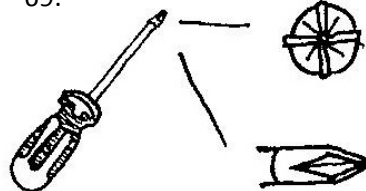

\_\_\_\_\_

\_\_\_\_\_

\_\_\_\_\_

\_\_\_\_\_

\_\_\_\_\_

\_\_\_\_\_

70.

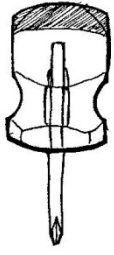

\_\_\_\_\_

71.

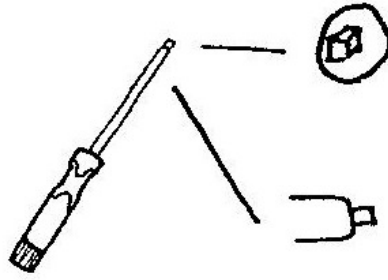

fact: \_\_\_\_\_

\_\_\_\_\_

N. Miscellaneous

72.

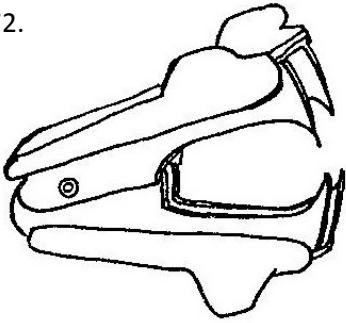

\_\_\_\_\_



