

Subject: \_\_\_\_\_ Section: \_\_\_\_\_  
Date: \_\_\_\_\_ 201 \_\_\_\_\_

Name: \_\_\_\_\_  
Period: \_\_\_\_\_

**SIR WINSTON CHURCHILL SECONDARY ELECTRONICS**

# **TOOL IDENTIFICATION- Key**

Line drawings created by Chantal Lo (2010).  
Package produced by Kivanç Yıldız.

September 1, 2010

A. Bending

1.

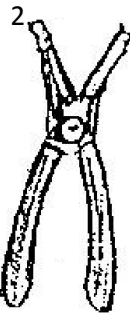
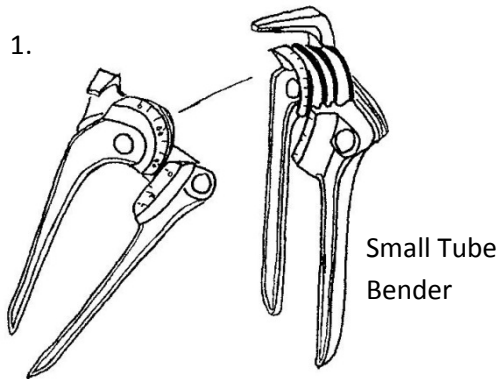

B. Clamping

3.

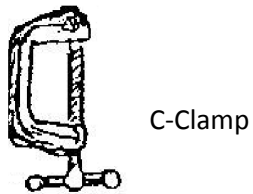

4.

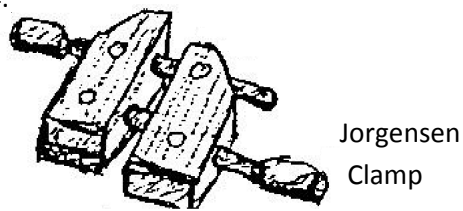

5.

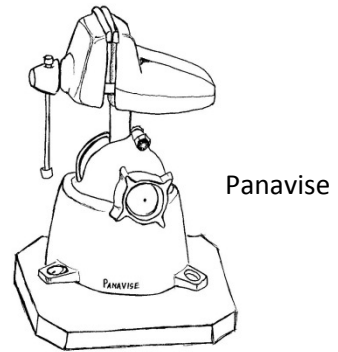

C. Cutting and Punching

6.

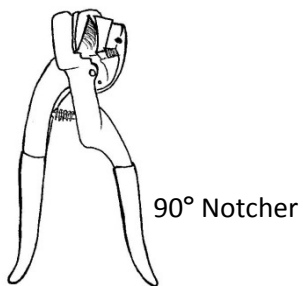

7.

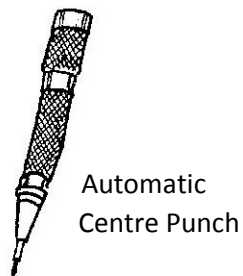

8.

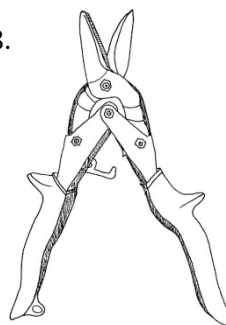

9.

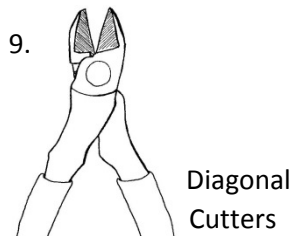

10.

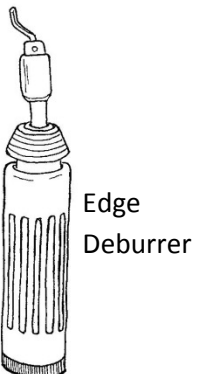

11.

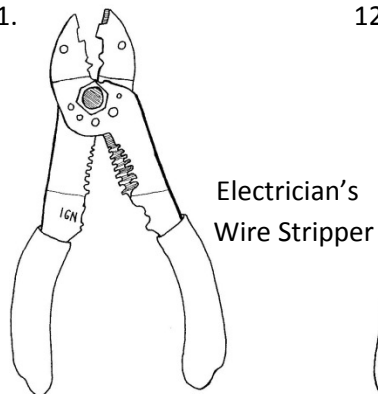

12.

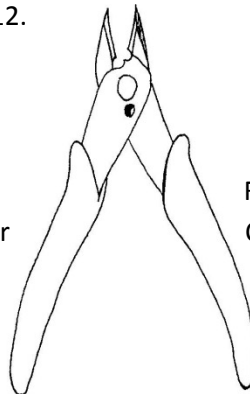

13.

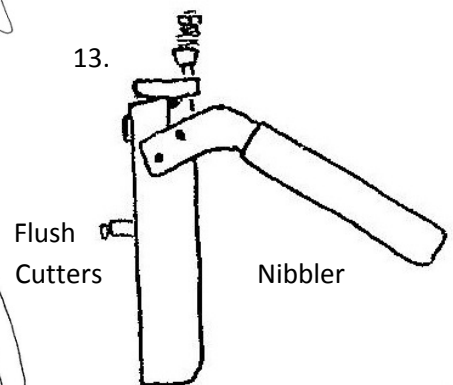

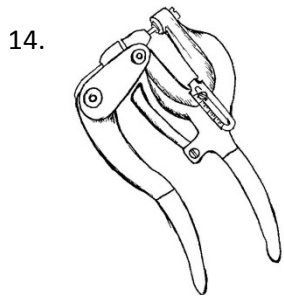

No. 5 Junior  
Whitney Punch

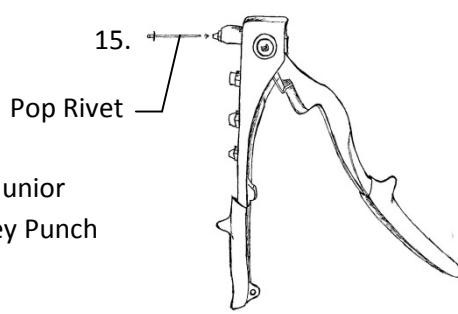

15. Pop Rivet

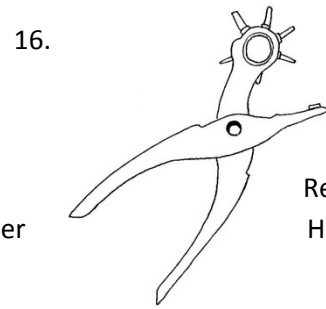

16. Pop Riveter  
Revolving  
Hole Punch



17. Scissors

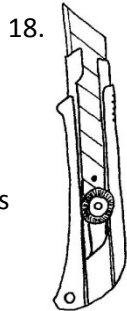

18. Utility  
Knife

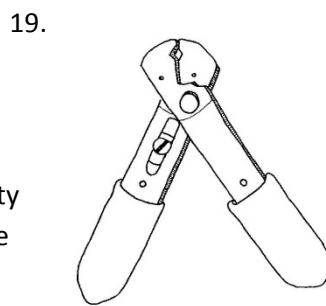

19. Wire  
Stripper

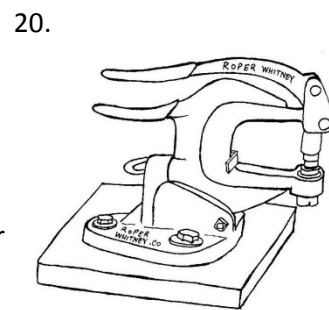

20. XX  
Whitney  
Punch



21. Countersink  
Deburrer

D. Drilling

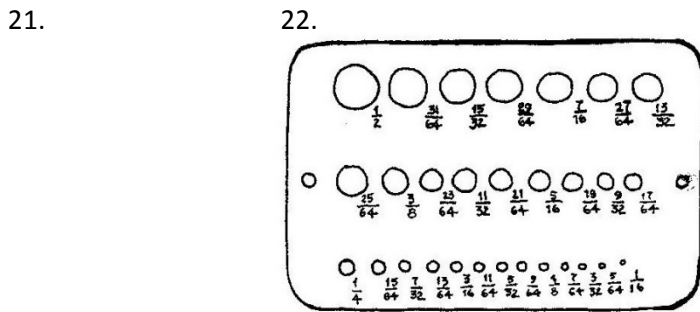

22. Drill Gauge

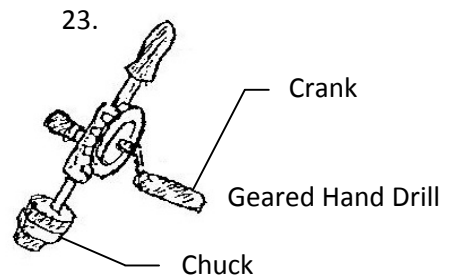

23. Crank  
Geared Hand Drill  
Chuck

High-Speed  
Twist Drill Bit

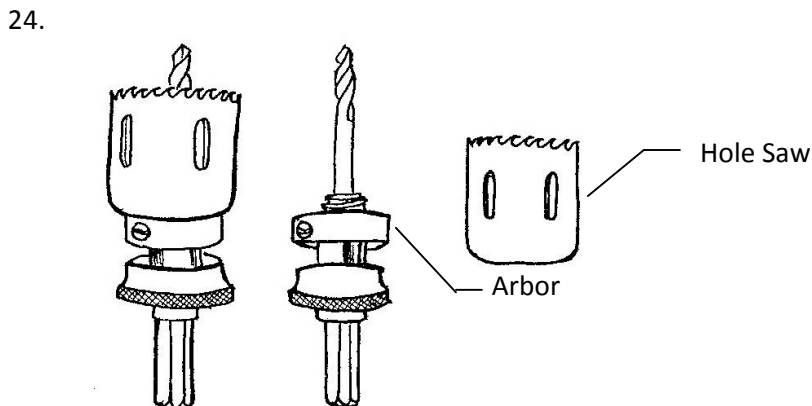

24. Hole Saw  
Arbor

25.

Hole Saw

Drill Index

E. Electronics

26.

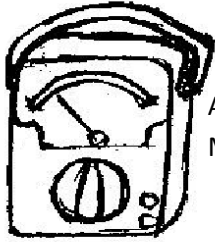

Analog Multimeter

27.

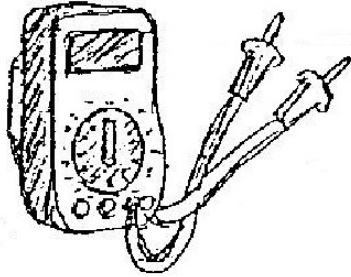

Digital Multimeter

28.

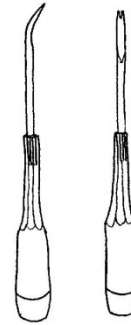

Chip Lifter

29.

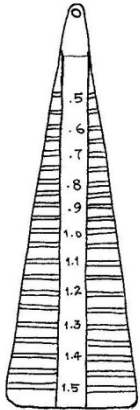

Resistor Bender

30.



Solder Vacuum

Solder Sucker

F. Files

31.



Double Cut Half-Round Smooth File

32.

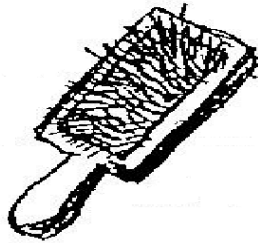

File Card

33.



34.



35.



Teeth

36.



Side

Flat  
Bastard  
File

Needle  
File

Rasp

Round File  
Rat Tail File

G. Hammers & Mallet

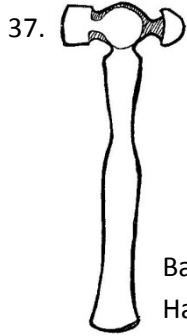

Ball Peen  
Hammer

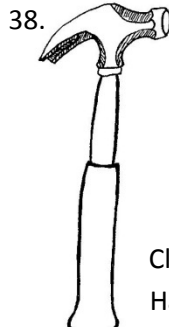

Claw  
Hammer

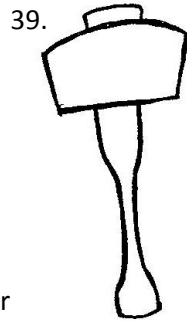

Carpenter's  
Beech  
Mallet



Sheet Metal  
Hammer

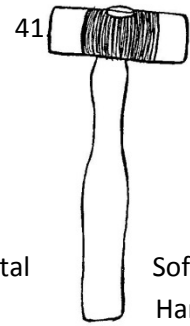

Soft-faced  
Hammer

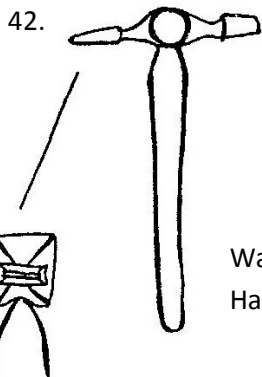

Warrington  
Hammer

43.

Rubber  
Hammer

H. Measuring & Layout

44.

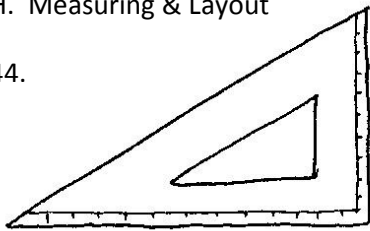

30-60-90°  
Set Square

45.

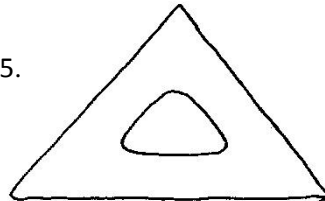

45-90°  
Set Square

46.

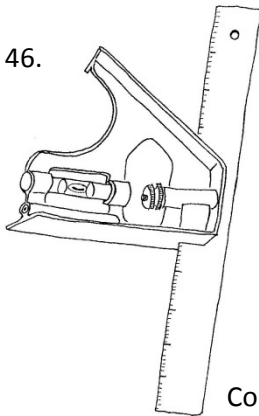

Combination  
Square

47.

48.

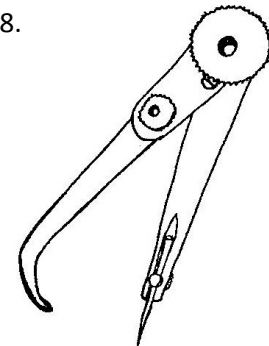

Hermaphrodite  
Caliper

Compass

49.

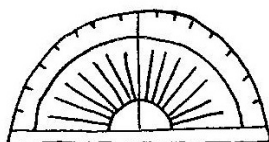

50.

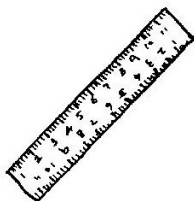

51.

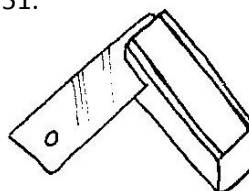

Protractor

Scale

Try-Square

52.

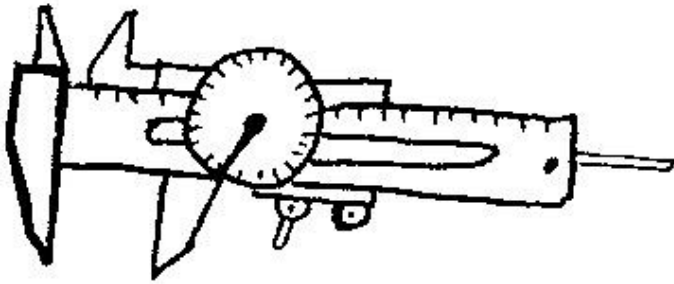

53.

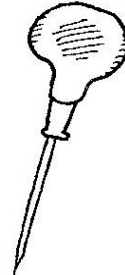

Vernier Caliper

Awl

J. Pliers

54.

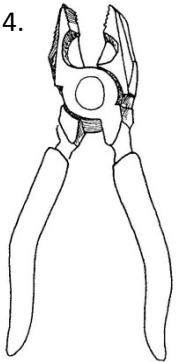

Lineman's Pliers

55.

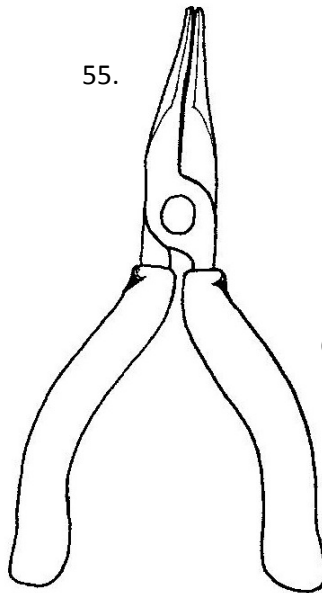

Chain-nose Pliers



Needle-nose Pliers

K. Ratchet, Sockets & Wrenches

56.

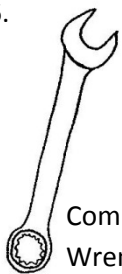

Combination Wrench

57.

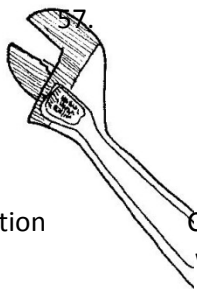

Crescent Wrench

Adjustable Wrench

58.

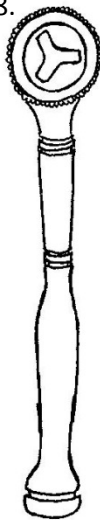

Ratchet

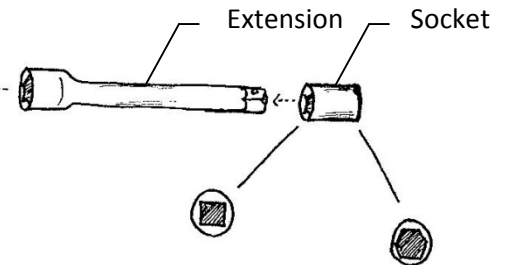
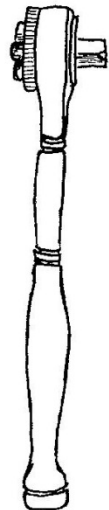

Extension

Socket

L. Saws

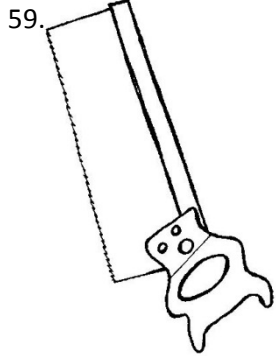

Back Saw

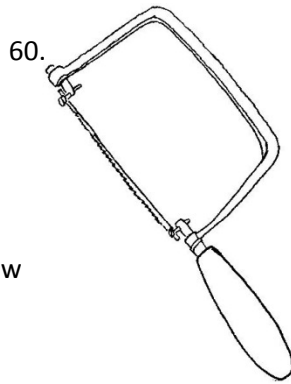

Coping Saw

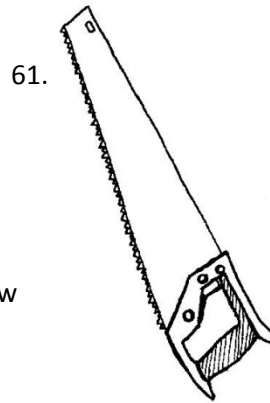

Crosscut Saw

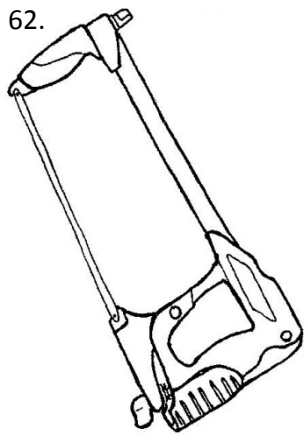

Hacksaw

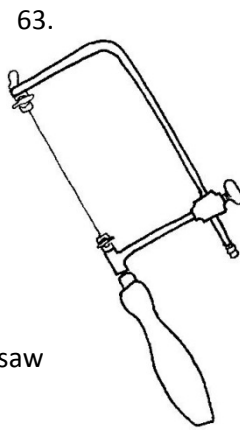

Jeweller's Saw

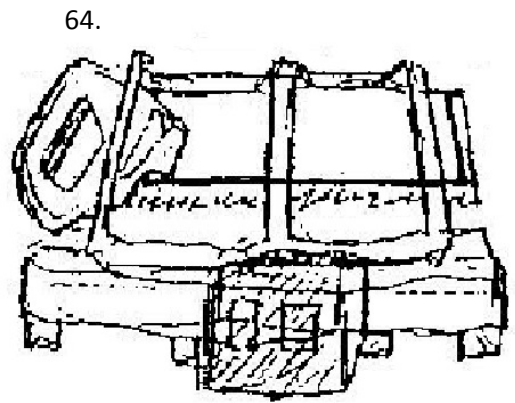

Mitre Saw

M. Screwdrivers

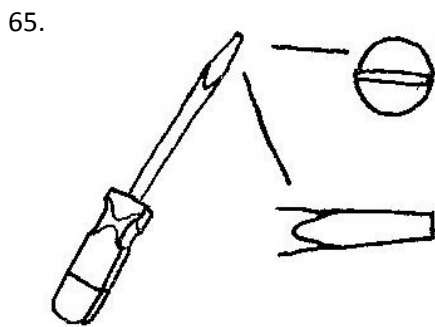

Electrician's Slotted Screwdriver

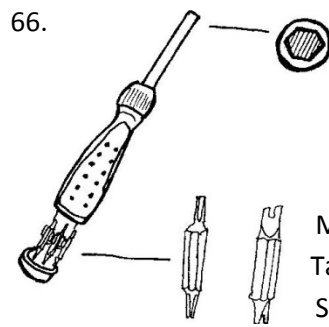

Megapro Tamperproof Screwdriver

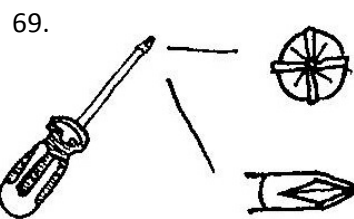
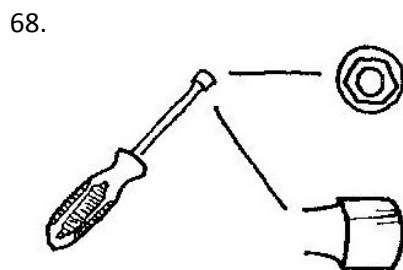
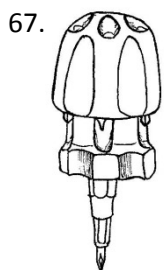

Stubby  
Multibit

70.

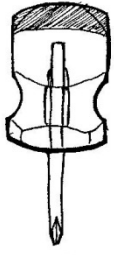

Stubby Phillips

Nut  
Driver

71.

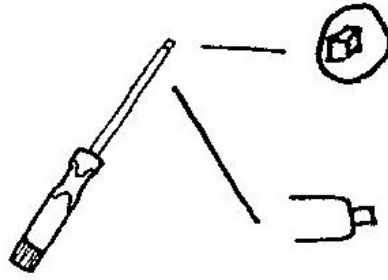

Robertson Screwdriver  
(Canadian 1907)

Phillips  
Screwdriver

N. Miscellaneous

72.

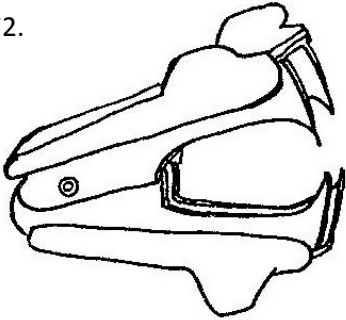

Staple Remover



